

# BroilVection™ Model JF94 Gas Owner's Manual



**APPROVALS:**



**FOR YOUR SAFETY:**

Do not store or use gasoline or other flammable vapors or liquids in the vicinity of this or any other appliance.

**WARNING:**

Improper installation, adjustment, alteration, maintenance can cause property damage, injury, or death. Read the installation, operating and maintenance instructions thoroughly before installing or servicing this equipment.

Broiler area must be kept free of combustible materials, and the flow of combustion and ventilation air must not be obstructed. Operating personnel must not perform any maintenance or repair functions. Contact your Nieco Authorized Dealer.

**IMPORTANT: RETAIN THIS MANUAL IN A SAFE PLACE FOR FUTURE REFERENCE**

# TABLE OF CONTENTS

<b>A. General Information</b>	<b>3</b>
A.1 Description	3
A.2 Warranty Information	3
A.3 Service/Technical Assistance	4
A.4 Safety Information	4
<b>B. Machine Installation</b>	<b>6</b>
B.1 Pre-Installation	6
B.2 Mounting	6
B.3 Leveling	6
B.4 Hood Requirements	6
B.5 Clearance	6
B.6 Gas Connection	7
B.7 Flexible Gas Line Installation	7
B.8 Restraining Device	8
B.9 Electrical Connection	8
B.10 Pre-Operation Check	8
<b>C. Operation</b>	<b>9</b>
C.1 Controls and Indicators	9
C.2 Step-by-Step Lighting Procedure	11
C.3 Shutdown Procedure	12
C.4 Control Operation	13
<b>D. Assembly/Disassembly and Cleaning</b>	<b>16</b>
<b>E. Troubleshooting Guide</b>	<b>30</b>
<b>F. Parts Location Drawings</b>	<b>31</b>
<b>G. Parts Replacement List</b>	<b>35</b>
<b>H. Wiring Diagrams</b>	<b>38</b>
<b>I. Specifications</b>	<b>43</b>

# A. GENERAL INFORMATION

## A.1 Description

The Nieco® Model JF94G automatic broiler features high release convection burners, Patent pending BroilVection™ air system that uses waste heat to greatly reduce energy needs, easy cleaning and a simple and intuitive control package to help eliminate broiling problems and provide the operator with even greater control over the broiling environment.

This manual provides the safety, installation and operating procedures for the Nieco Automatic Broiler Model JF94. We recommend that all information contained in this manual be read prior to installing and operating the broiler.

## A.2 Warranty Information

Please read the full text of the limited Warranty in this manual.

If the unit arrives damaged, contact the carrier immediately and file a damage claim with them. Save all packing materials when filing a claim. Freight damage claims are the responsibility of the purchaser and **ARE NOT** covered under warranty.

The warranty **does not** extend to:

- Damages caused in shipment or damage as a result of improper use.
- Installation of electrical service.
- Normal maintenance as outlined in this manual.
- Malfunction resulting from improper maintenance not in accordance with the steps contained in this manual and any applicable training.
- Damage caused by abuse or careless handling outside of the normal operating procedures contained in this manual.
- Damage from moisture into electrical components.
- Damage from tampering with or removal of any safety device.

### **IMPORTANT!**

**Keep these instructions for future reference. If the unit changes ownership, be sure this manual accompanies the equipment.**

### **IMPORTANT**

**The Nieco Corporation reserves the right to change specifications and product design in accordance with the general terms and conditions outlined in the BURGER KING®/Vendor agreement. Such revisions do not entitle the buyer to corresponding changes, improvements, additions or replacements for previously purchased equipment.**

### A.3 Service/Technical Assistance

If you experience any problems with the installation or operation of your broiler, contact your local Authorized Nieco Distributor.

Fill in the information bellow and have it handy when calling your authorized service agency for assistance. The serial number is on the broiler rating plate on the back of the unit.

Purchased from: \_\_\_\_\_

Date of Purchase: \_\_\_\_\_

Model No.: \_\_\_\_\_

Serial No.: \_\_\_\_\_



For the name of your local Authorized Nieco Distributor, please call (800) 821-2141.



Use only genuine Nieco replacement parts in your broiler. Use of replacement parts other than those supplied by Authorized Nieco Distributors and Service Agencies will void the warranty and may significantly alter the performance of your broiler. The use of non-Nieco parts is capable of affecting these criteria, and may affect broiler performance, parts longevity and food safety. Your local Authorized Nieco Distributor and Service Agent has been factory trained and has a complete supply of parts for your Nieco Automatic Broiler.



You may contact the factory direct at +1-707-284-7100 if you have trouble locating your local Nieco Distributor.



### A.4 Important Safety Information

Throughout this manual, you will find the following safety words and symbols that signify important safety issues with regards to operating or maintaining the equipment:

 <b>WARNING</b> 
<b>GENERAL WARNING.</b> Indicates information important to the proper operation of the equipment. Failure to observe may result in damage to the equipment and/or severe bodily

 <b>WARNING</b> 
<b>ELECTRICAL WARNING.</b> Indicates information relating to possible shock hazard. Failure to observe may result in damage to the equipment and/or severe bodily injury or

 <b>CAUTION</b> 
<b>GENERAL CAUTION.</b> Indicates information important to the proper operation of the equipment. Failure to observe may result in damage to the equipment.

 <b>WARNING</b> 
<b>HOT SURFACE WARNING.</b> Indicates information important to the handling of equipment and parts. Failure to observe caution could result in personal injury.

## A.4 Important Safety Information (Continued.)

In addition to the warnings and cautions in this manual, use the following guidelines for safe operation of your Nieco Automatic Broiler:

- Read and follow all instructions before using this equipment.
- Install or locate broiler only for its intended use as described in this manual.
- Do not operate this equipment if it has a damaged cord or plug, if it is not working properly or if it has been otherwise damaged.
- This equipment should only be serviced by authorized personnel. Contact your local Nieco Distributor for adjustment or repair.
- Use only genuine Nieco replacement parts for your broiler. Failure to do so will void the warranty and may significantly alter the performance of your broiler. The use of non-Nieco parts is capable of affecting these criteria, and may affect broiler performance, parts longevity and food safety.

**The following warnings and cautions appear throughout the manual and should be carefully observed:**

- **Turn the broiler off, close the main gas valve, and disconnect the plug before performing any service, maintenance or cleaning on the broiler.**
- **Always allow the broiler to fully cool before performing any service, maintenance or cleaning. Failure to wait for the broiler to cool fully may result in personal injury.**
- **The procedures in this manual may include reference to the use of chemical products. The Nieco Corporation does not endorse the use of any particular cleaning/degreasing agent. Use only those chemicals that are approved for use in your kitchen.**
- **The broiler should be grounded according to local electrical codes to prevent the possibility of electrical shock. It requires a grounded receptacle with separate electrical lines, protected by fuses or circuit breakers of the proper rating.**
- **All electrical connections must be in accordance with local electrical codes and any other applicable codes.**
- **The use of adequate ventilation (as rated in this manual) with this broiler is mandatory. Failure to adequately ventilate this unit and provide safe operating distances (as specified in this manual) is a fire safety hazard. Follow the instructions for emergency broiler shutdown in the event of an emergency.**
- **No attempt should be made to operate this appliance in the event of a power failure.**

**WARNING ELECTRICAL SHOCK HAZARD. FAILURE TO FOLLOW THESE INSTRUCTIONS COULD RESULT IN SERIOUS INJURY OR DEATH:**

- **Electrical ground is required on this appliance.**
- **Check with a qualified electrician if you are in doubt as to whether the appliance is properly grounded.**
- **Do not use water on or near the control box for risk of serious injury or death due to electrical shock.**

**WARNING, HIGH TEMPERATURES WITH HOT SURFACES. FAILURE TO FOLLOW THESE PROCEDURES COULD RESULT IN SERIOUS INJURY:**

- **Do not attempt to clean, disassemble or perform maintenance on this broiler until it is fully cooled as per the instructions contained in this manual.**

## B. INSTALLATION

### B.1 Pre-Installation

Uncrate the broiler and inspect for shipping damage. Remove the tape securing the machine parts, and install the parts in their proper location. If there are obvious or concealed damages to any part of the broiler, please contact your freight carrier. The factory warranty does not cover freight damage.

### B.2 Mounting

Follow the mounting instructions if this function is not performed by the installer.

### B.3 Leveling

The grease drain system is based on a gravity-flow design. Therefore, it is extremely important that the broiler be placed on a level surface.

### B.4 Hood Requirements

This appliance must be installed under a ventilation hood of adequate size. Do not obstruct the flow of combustion and ventilation air. An adequate air supply must be available for safe and proper operation.

For installations in the Commonwealth of Massachusetts the following shall apply: Venting shall be in compliance with NFPA Section 10.3.5.2 for the Model JF93.

### B.5 Clearance

Keep appliance area free from combustibles.

To facilitate disassembly and service of the unit a minimum of 24" (610 mm) should be allowed on the control panel (feed end) of the broiler.

#### REQUIRED AND RECOMMENDED CLEARANCES

	<b>REQUIRED</b> for installation near combustible walls and construction	<b>REQUIRED</b> for installation near non-combustible walls and construction	<b>RECOMMENDED</b> by Nieco for proper disassembly and service
Back of broiler	12" (305 mm)	0" (0 mm)	0" (0 mm)
Sides of broiler	12" (305 mm)	0" (0 mm)	0" (0 mm)
Front of broiler (Feed end)	12" (305 mm)	0" (0 mm)	24" (610 mm)



## B.6 Gas Connection- 3/4" N.P.T.

At rated input the gas supply should deliver a minimum pressure of at least 15 mbar (6" water column) at the broiler connection for natural gas. Incoming gas supply pressure must not exceed 50 mbar (14" water column).

**Note:** The installation of this appliance must conform with local codes, or in the absence of local codes, with the National Fuel Gas Code, ANSI Z223.1, Natural Gas Installation Code, CAN/CGA-B149.1 including:

1. The appliance and its individual shutoff valve must be disconnected from the gas supply piping system during any pressure testing of that system at test pressures in excess of 1/2 psi (3.45 kPa).
2. The appliance must be isolated from the gas supply piping system by closing its individual manual shutoff valve during any pressure testing of the gas supply piping system at test pressures equal to or less than 1/2 psi (3.45 kPa).

By public initiative, the State of California has adopted legislation (Proposition 65) which requires manufacturers of many types of products, including gas appliances, to warn consumers of their products that contain chemicals or produce substances listed by the State of California to either cause cancer, birth defects or other reproductive harm.

	<b>WARNING</b>	
<b>If not installed, operated and maintained in accordance with the manufacturers instructions, this product could expose you to substances in fuel or from fuel combustion which can cause cancer, birth defects or other reproductive harm.</b>		

## B.7 Installing Gas Appliance Connectors and Flexible Gas Lines Correctly

For safety in the kitchen area, and to insure maximum service life, it is vitally important to correctly install connectors. The connector shall comply with the Standard for Connectors for Moveable Gas Appliances, ANSI Z21.69 or CAN/CGA-6.16 and a quick disconnect device that complies with the Standard for Quick-Disconnect Devices for use with gas fuel, ANSI Z21.41 or CAN1-6.9

In order to avoid sharp kinks or excessive bends that could have a damaging effect on the connector, it may be necessary to attach pipe elbows in order to bring the connector into its proper plane. For easy movement of the appliance, the connector should be installed with a "lazy" loop for minimum tension.

**Note: Gas appliances should be disconnected prior to maximum movement. (Minimal movement is possible to connect hose.)**

## B.8 Restraining Device Installation and Use

This high strength restrainer is to be used with all moveable (castered) appliances. It fully complies with American Gas Association requirements. References: Z21.69, Z83.11, and Z21.41 with current revisions. Installation is quick and positive. In Canada, device is in accordance with CAN 1-6.9-M70 Quick Disconnect Devices for use with gas fuel, and CAN 1-6.10-88 metal connectors for gas appliances. Correct length for any appliance is simply a matter of loosening two adjuster clips (1) and re-tightening. (3" to 6" shorter than appliance connector is desired length.) Restrainer is made of heavy duty steel cable, with a strong scissor hood (2) at one end, and an equally strong spring hook (3) at the other. Cotter pin (4) is supplied to secure the installation. For proper attachment to the broiler, use the supplied hardware to attach the device to the holes in the shear plate of the broiler stand.

**NOTE: If disconnection of the restraint is necessary, reconnect the restraint after the appliance has been returned to its originally installed position.**

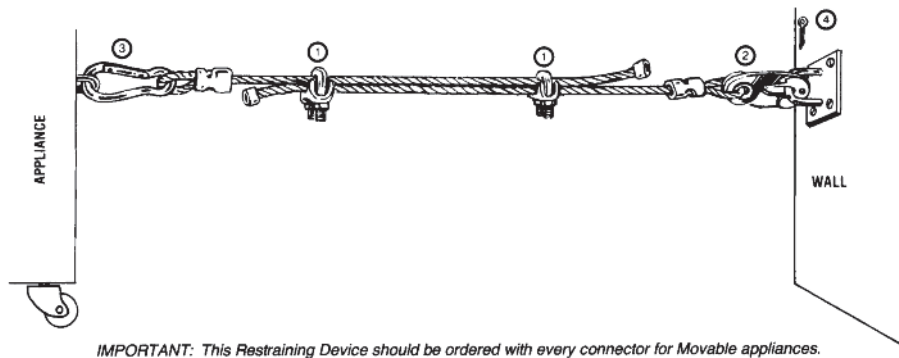

## B.9 Electrical Connection

Power requirements are stated on the unit nameplate and must be connected accordingly. This appliance, when installed must be electrically grounded in accordance with local codes, or in the absence of local codes, with the National Electrical Code, ANSI/NFPA 70, or the Canadian Electrical Code, CSA C22.2, as applicable. Before starting broiler, tighten all electrical connections in control box. An electrical wiring diagram can be found inside the control box.

**Note:** Disconnect power before servicing.

## B.10 Pre-Operation Check

Be sure that all parts are installed in the proper location:

- Ventilation is turned on
- Broiler is plugged in
- Gas line is connected



# C. OPERATION

## C.1 Controls and Indicators

### ON THE MAIN SIDE

1. Belt Speed Control (P/N 13727-B) - Used to set the broil time on the meat belt.
2. Temperature Control (P/N 19076) - Helps keep the broiler temperature stable when the broiler is under heavy load.



### ON THE FLEX SIDE

1. Multi Product Control (P/N 15161-B) - Used to broil a variety of products that may require different settings (WHOPPERS®, Chicken, XT)
2. Main on/off switch. Used to turn the power on or off to the broiler.
3. Power indicator light. Glows green when the power to the broiler is turned on.
4. Ignition failure light. This light will flash if the broiler burners fail to ignite. Cycle the on/off switch to reset. Check the troubleshooting guide if the broiler fails to light.



## C.1 Controls and Indicators (Continued.)

### ON THE BACK OF THE BROILER

1. Belt reverse buttons. Press and hold these buttons to reverse the direction of the belt to help free a belt jam.
2. Shaft cleaning tool. Use this tool on the drive and idler shafts to scrape them clean.

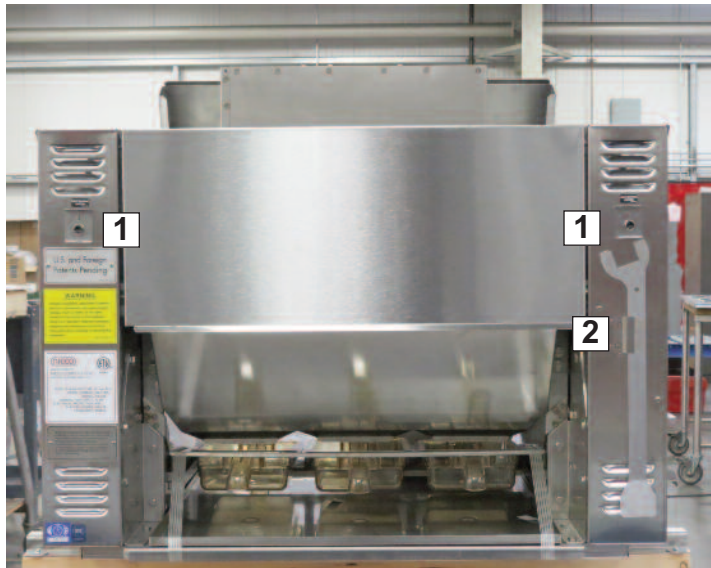

### MULTI-PRODUCT CONTROL

1. LED DISPLAY - Shows current product selection and cook time.
2. PRODUCT SELECTION BUTTONS - Press to select different presets for different products.
3. ADJUSTMENT BUTTONS - Use to adjust product cook times, element settings and product names.
4. SELECTION INDICATOR LIGHT - Lights up to show which button is selected.

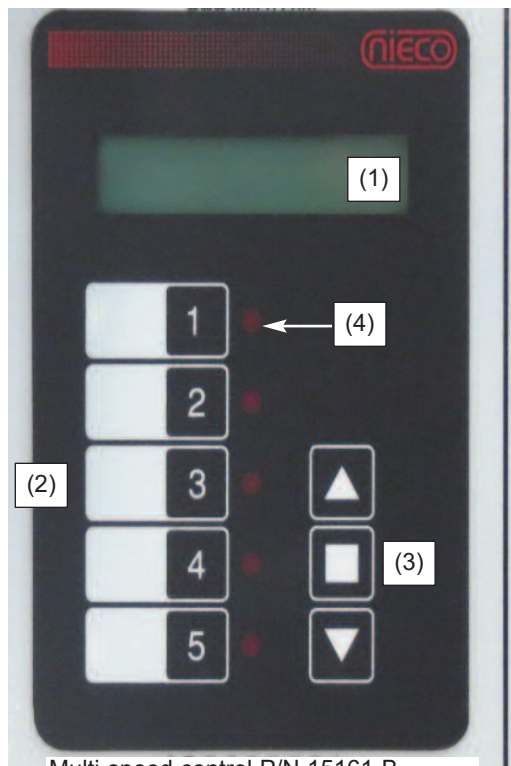

Multi-speed control P/N 15161-B

## C.2 Lighting Procedures

### PRE-LIGHTING PREPARATION

1. Broiler is centered under hood and plugged in
2. Gas valve is open when handle is in line (parallel to) the pipe
3. Turn ventilation system on

#### **⚠ WARNING ⚠**

**THE VENTILATION SYSTEM MUST BE ON AT ALL TIMES DURING BROILER OPERATION. OPERATING BROILER WITHOUT PROPER VENTILATION IS A SEVERE FIRE HAZARD.**

### NORMAL IGNITION

The JF94 is equipped with automatic ignition. When the broiler is turned on, a hot surface ignitor turns on 5 seconds before the flow of gas. Gas then flows to all of the burners. If the burners are not lit within 10 seconds, the control will reset and try again for 10 seconds. This occurs 3 times. If the broiler does not light after the third attempt, the ignition failure light will flash and the main on/off switch must be cycled to repeat the procedure. If this still doesn't light the broiler, see the MANUAL IGNITION instructions.

1. Turn the **MAIN POWER SWITCH** on.

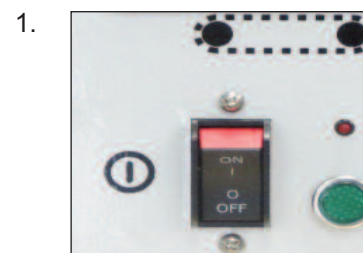

2. Allow broiler to heat for 45 minutes before cooking.



## C.2 Lighting Procedures (Continued.)

### MANUAL IGNITION

1. Remove the Return Slide. Turn the **MAIN POWER SWITCH** on. Hold a lighter/match to the Upper Burner on the discharge end until the burner lights. Once the first burner is lit, verify that all burners have ignited.



## C.3 Shutdown Procedures

### PLANNED SHUTDOWN

1. Allow the broiler to run free of any product for 10 minutes. This will burn the chain clean.

2. Close the main gas valve and allow the broiler to run without gas for 10 minutes.

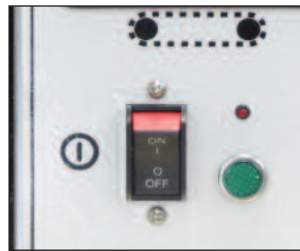

3. Turn off the **Main Power Switch**.

4. Wait for the broiler to cool.

### EMERGENCY SHUTDOWN

1. Turn off the **MAIN POWER SWITCH**.

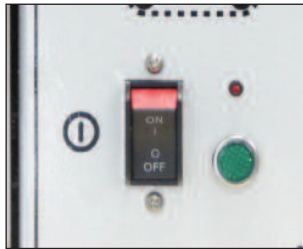

2. Close the **MAIN GAS VALVE**

Valve is closed when it is perpendicular to pipe.



Your Nieco Automatic Broiler is designed to automatically stop gas flow to the broiler in the event of power failure, gas pressure loss or any other related incident. No attempt to operate this appliance should be made in the event of a power failure.

#### **⚠ CAUTION ⚠**

In a prominent location, post instructions to be followed in the event the user smells gas. This information shall be obtained by consulting your local gas supplier.

#### **⚠ CAUTION ⚠**

**FOR YOUR SAFETY:** Do not store or use gasoline or other flammable vapors or liquids in the vicinity of this or any other appliance.

#### **⚠ CAUTION ⚠**

**FOR YOUR SAFETY:** In the event of a prolonged power failure, no attempt should be made to operate this appliance.

## C.4 Control Operation

**IMPORTANT: THIS BROILER IS SHIPPED WITH FACTORY PRESETS THAT MUST BE CHANGED.**

If this is the initial start-up for your broiler, ALL control settings must be made according to BURGER KING® specifications. Follow the steps outlined for calibration and changing preset times.

### MAIN SIDE CONTROLS

#### 1. SETTING BELT SPEEDS

Press up arrow to increase broil time; press the down arrow to decrease broil time. After you have set the control the display will be flashing. Press the center square to save your changes. NOTE: After making changes to the broil time, if you do not press the center square button, your changes will not be saved.

Use the up and down arrows to set the time. Press the center square button to save your changes.



#### 2. TEMPERATURE CONTROL

Gas broilers are equipped with a Broil Temperature Stabilizer Control that senses when the broiler is being used, and adjusts the temperature to keep the broiler hot during heavy use. The control consists of two parts - a temperature probe to sense the internal temperature of the broiler, and the control itself.



#### 3. CALIBRATING THE TEMPERATURE CONTROL

In order to assure proper operation, the Temperature Control must be set for operation in the restaurant. Follow these step by step instructions when the broiler is new, and once per month after.

Step 1: Be sure all pieces of the broiler are in place. Make sure the broiler is plugged in and the exhaust hood is turned on. Turn the broiler on.

Step 2: Set the temperature (bottom number) to 1000° F (537° C). Use the up or down arrows on the control to set the temperature. Leave the broiler at 1000° F for 25 minutes. DO NOT COOK DURING THIS TIME. After the 25 minutes is up, use the arrows to put the set point to the actual temperature. The bottom number is the set temperature and the top number is the actual temperature.

## FLEX SIDE CONTROLS

### 1. Multi-Product Control

How it works: The multi-product control is designed to let you broil different products on the flex side of the broiler. The control allows you to have different broiler settings for each product selection button. Use a grease pen to mark the white area with the product name.

### 2. Normal Operation

Press the product selection button (number) for the product you wish to cook. The display will show the product name and cook time and the light next to the product selection button will be lit.

NOTE: Be sure the belt is clear of any products before pressing a new product selection button.

### 3. Changing Belt Speeds

Push the product selection button (1) you want to adjust then push the up and down (2) arrows to make changes, then press the center square button (3) to save them.

### 4. Changing Burner Settings

Press the product selection button you wish to change. Press the product selection button twice (2X) to get to the burner selection screen. Push the up or down button to YES or NO. When you are done making changes, press the center square button after you are done adjusting the burner to save your changes.



### 5. Changing Product Names

Push the product selection button which you want to make a name to. Press and hold the center square button for 15 seconds. The control will enter the edit name screen for that button. Use the up and down buttons to change the characters. Press center square button once to move to the next character until you are finished editing the product name for that button (10 character limit). Press and hold the PRODUCT SELECTION BUTTON for 5 seconds to save the changes and return to normal operation.



## D. CLEANING AND DISASSEMBLY

Turn broiler off and close the main gas valve. Disconnect the power supply to the broiler before cleaning or servicing. If this broiler is connected using a restraint, and disconnection of the restraint is necessary for cleaning or moving the broiler, the restraint must be reconnected after the broiler has been returned to its originally installed position. Allow to cool for 30 minutes prior to cleaning/disassembly. Leave the ventilation system on during cooling. Use only approved cleaning, degreasing and sanitizing solutions.

### ⚠ WARNING ⚠

LEAVE THE VENTILATION HOOD ON DURING COOLING. FAILURE TO DO SO COULD POSE A FIRE SAFETY HAZARD.

### ⚠ CAUTION ⚠

Follow the Disassembly and Reassembly steps to ensure proper operation of the broiler. Failure to do so may result in operational problems.

### ⚠ WARNING ⚠

BROILER PARTS ARE HOT. DO NOT ATTEMPT TO DISASSEMBLE THE BROILER UNTIL IT IS FULLY COOL. FAILURE TO FOLLOW THIS INSTRUCTION MAY RESULT IN SEVERE INJURY.

**ALL PARTS ARE CLEANED ON A DAILY BASIS UNLESS OTHERWISE NOTED**

Follow the steps for proper disassembly. Reverse the order for reassembly.

## How to read the cleaning section

The name of the part to be cleaned.      The location of the part.      When to clean the part.

The tools needed to clean the part

How to remove and clean the parts.

Picture of the part to be removed and cleaned.

The diagram illustrates the components of a cleaning instruction card. At the top, three labels point to specific parts: 'Meat Guides' (the part name), 'Feed End' (the location), and 'Clean: Every 4 hours' (the frequency). Below these, a 'Tools' section lists a '3-Compartment Sink' and a 'Scrub Pad'. An 'Instructions' section provides a two-step process: 1. Pull each meat guide out slightly from the bottom, then lift off. 2. Wash, rinse, and sanitize in the 3-compartment sink. To the right, a photograph shows a hand removing a meat guide from a broiler, with a label pointing to it as the part to be cleaned.



# Cleaning the Broiler



## Tools Needed

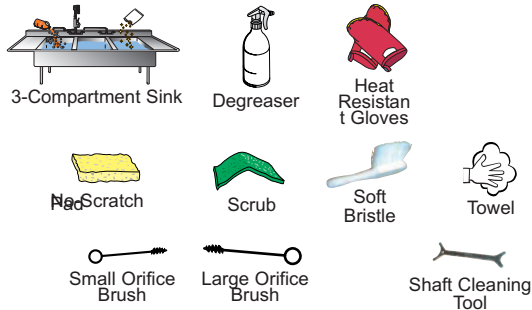

**STOP**

## Important Symbols



This “Stop” sign shows a step in the procedure that must be followed exactly or personal safety could be affected.



This warning symbol shows a step in the procedure that must be followed exactly or broiler performance could be affected.



This “puzzle” symbol shows a step in the reassembly procedure that must be followed.



## Instructions

1. Allow the broiler to run free of product for 10 minutes before turning it off. This allows any residue to burn off the chains.
2. Shut the broiler off and let it cool for 30 minutes before disassembly and cleaning.
3. Close the main gas valve and unplug the broiler before cleaning.
4. Always leave the ventilation hood on during the 30 minute cool down period.
5. Use only approved cleaning solutions.
6. Allow parts to air dry after cleaning.

# Meat Guides

**Clean: Every 4 hours**



## Tools

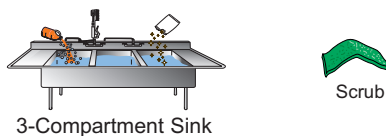

## Instructions

1. Lift the meat guides up and off the feeder.
2. Wash, rinse, and sanitize in the 3-compartment sink.

## Feed End



## Feeder Cover

Clean: Every 4 hours



### Tools

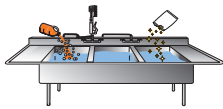

3-Compartment Sink



Scrub Pad



### Instructions

1. Slide the feeder cover towards you until it comes off.
2. Wash, rinse, and sanitize in the 3-compartment sink.

### Feed End



## Push Bar Feeder Base (2)

Clean: Every 4 hours



### Tools

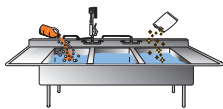

3-Compartment Sink



Scrub



### Instructions

1. Pull the release pin.
2. Lift push bar feeder bases up and off.
3. Wash, rinse, and sanitize in the 3-compartment sink.

 **DO NOT** lift the feeder base by the feeder bar or the chains. This will damage the feeder base.

 **REASSEMBLY:** Pull the release pin and place feeder base in position.

### Feed End



## Wire Belt Feeder Base (If equipped)

Clean: Every 4 hours



### Tools

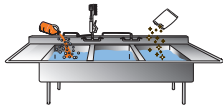

3-Compartment Sink



Scrub



### Instructions

1. Pull the release pin.
2. Lift wire belt feeder base up and off.
3. Wash, rinse, and sanitize in the 3-compartment sink.

 **DO NOT** lift the feeder base by the wire belt. This will damage the feeder base.

 **REASSEMBLY:** Pull the release pin and place feeder base in position.

### Feed End



## Feeder Housing

Clean: Daily



### Tools

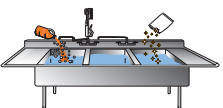

3-Compartment Sink



Scrub



### Instructions

1. Lift and remove.
2. Wash, rinse, and sanitize in the 3-compartment sink.

 **REASSEMBLY:** Hang feeder housing on brackets.

### Feed End



## Grease Pan

Clean: Daily



### Tools



Heat Resistant



Scrub Pad



Degreaser

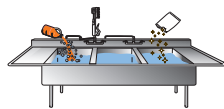

3-Compartment Sink



### Instructions

1. Slide grease pan out.

**!** Make sure grease pan is cool before putting in water or it may warp the pans.

2. Take to sink area and spray with degreaser.

3. Wash with a scrub pad, rinse, and sanitize in the 3-compartment sink.

### Feed End



## Warming Pan Shield

Clean: Daily



### Tools



Heat Resistant



Scrub Pad



Degreaser

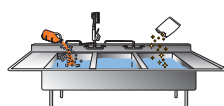

3-Compartment Sink



### Instructions

1. Slide warming pan shield out.

2. Take to sink area and spray with degreaser.

3. Wash with a scrub pad, rinse, and sanitize in the 3-compartment sink.

### Feed End



## Holding Pan Bracket

Clean: Daily



### Tools



Heat Resistant



Scrub Pad



Degreaser

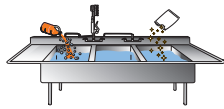

3-Compartment Sink



### Instructions

1. Lift and slide bracket out.
2. Take to sink area and spray with degreaser.
3. Wash with a scrub pad, rinse, and sanitize in the 3-compartment sink.

### Feed End



## Crumb Tray

Clean: Daily



### Tools



Heat Resistant



Scrub Pad



Degreaser

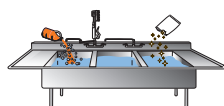

3-Compartment Sink



### Instructions

1. Slide crumb tray out.
2. Take to sink area and spray with degreaser.
3. Wash with a scrub pad, rinse, and sanitize in the 3-compartment sink.

### Feed End



## Product Holding Area

Clean: Daily



### Tools



Soapy



Sanitized



### Instructions

1. Clean product holding area while still warm.
2. Wring out a soapy towel and wash product holding area.
3. Wring out a sanitized towel and wipe product holding area.

### Feed End



## Discharge Heat Shield

Clean: Daily



### Tools



Heat Resistant



Scrub Pad



Degreaser

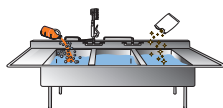

3-Compartment Sink



### Instructions

1. Lift up and off.
2. Take to sink area and spray with degreaser.
3. Wash, rinse, and sanitize in the 3-compartment sink.

### Discharge End





## Tools



Heat Resistant



Scrub Pad



Degreaser

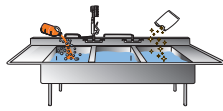

3-Compartment Sink



## Instructions

1. Tilt and lift pins off hooks; lift off.
2. Take to sink area and spray with degreaser.
3. Wash, rinse, and sanitize in the 3-compartment sink.

 **REASSEMBLY:** Make sure pan inserts are on and return pan hangs on brackets.

## Discharge End



## Tools



Heat Resistant



Scrub Pad



Degreaser

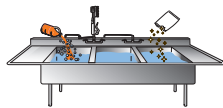

3-Compartment Sink



## Instructions

1. Tilt stripper blade away from chain; lift off brackets.

 **Make sure stripper blade is cool before putting in water or it may warp.**

2. Take to sink area and spray with degreaser.
3. Wash with a scrub pad, rinse, and sanitize in the 3-compartment sink.

 **REASSEMBLY:** Hang stripper blade on brackets.

## Discharge End



## Grease Box

Clean: Daily



### Tools



Heat Resistant



Scrub Pad



Degreaser

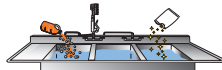

3-Compartment Sink



### Instructions

1. Lift and remove the grease box.
2. Take to sink area and spray with degreaser.
3. Wash with a scrub pad, rinse, and sanitize in the 3-compartment sink.

### Side



## Grease Trough

Clean: Daily



### Tools



Heat Resistant



Scrub Pad



Degreaser

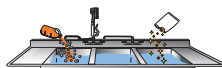

3-Compartment Sink



### Instructions

1. Lift and slide the grease trough out of the broiler.
2. Take to sink area and spray with degreaser.
3. Wash with a scrub pad, rinse, and sanitize in the 3-compartment sink.

 **REASSEMBLY:** Be sure grease trough is pushed all the way into the broiler.

### Side





## Lower Burner

Clean: Daily



### Tools



Heat Resistant

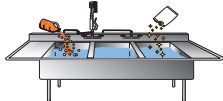

3-Compartment Sink





Scrub Pad



### Instructions

1. Lift the burner latch.
2. Slide burner out.
3. Take to the 3-compartment sink and scrub with a scrub pad or nylon brush.
4. If necessary, use a stiff toothbrush to clean any clogged burner holes.

 **REASSEMBLY:** Be sure the holes on the burner are facing up.

 **Warning:** Burner must be completely dry before reassembly. Dry with a paper towel.

### Side



## Incendalyst™

Clean: Daily



### Tools



Heat Resistant Gloves



### Instructions



**EXTREMELY HOT!** Be careful not to burn yourself.

1. Grasp handle and lift Incendalyst™ off to remove from chimney.
2. SOAK IN WARM WATER FOR 1 HOUR. RINSE WITH WATER ONLY. NEVER USE ANY CHEMICALS ON THE CATALYST.
3. Lay flat to drain water and let air dry overnight.
4. Make sure Incendalyst™ is dry before putting back on broiler.

### Top

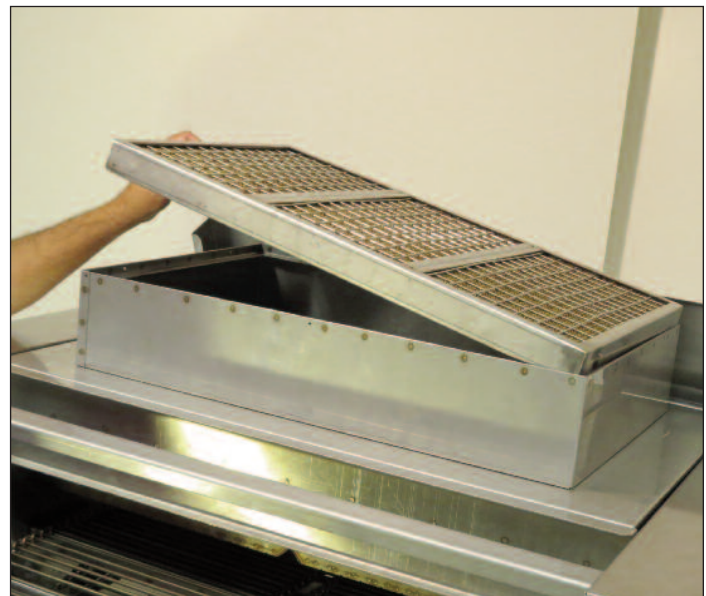

CAUTION: Extremely Hot 

# Incendalyst™ Chimney

Clean: Daily



## Tools



Heat Resistant



Scrub Pad



Degreaser

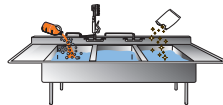

3-Compartment Sink



## Instructions



**EXTREMELY HOT!** Be careful not to burn yourself.

1. Lift Incendalyst™ chimney up and off.
2. Take to sink area and spray with degreaser.
3. Wash with a scrub pad, rinse, and sanitize in the 3-compartment sink.

## Top



CAUTION: Extremely Hot 

# Upper Heat Shield

Clean: Daily



## Tools



Heat Resistant Gloves



Scrub Pad



Degreaser

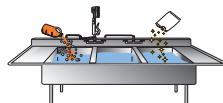

3-Compartment Sink



## Instructions



**EXTREMELY HOT!** Be careful not to burn yourself.

1. Lift upper heat shield up and off.
2. Take to sink area and spray with degreaser.
3. Wash with a scrub pad, rinse, and sanitize in the 3-compartment sink.
4. When reinstalling note that Heat Shield slopes upwards towards rear of broiler and legs are resting on rear airbox.

## Top



CAUTION: Extremely Hot 

## Chain Shafts

Clean: Daily



### Tools



Shaft Cleaning  
Tool



### Instructions

1. Scrape each shaft of both belts on the discharge end with the wide end of the shaft cleaning tool. The tool is located on the clip on the discharge end of the broiler.
2. Wipe shaft cleaning tool with a towel.

### Discharge End

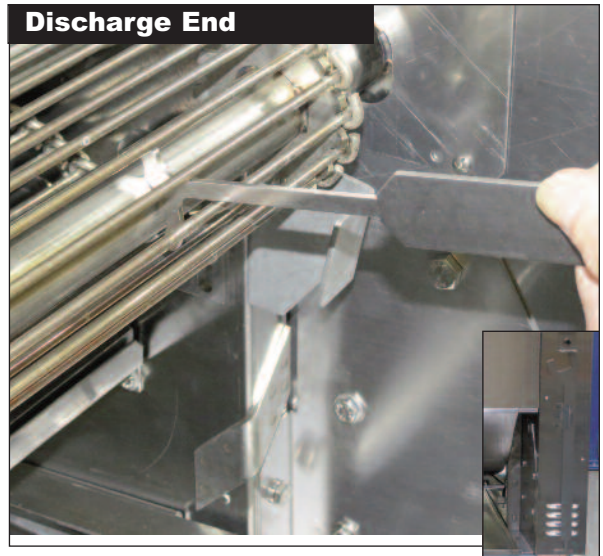

## INNER HEAT SHIELDS

Clean: Daily



### Tools



Shaft Cleaning  
Tool



### Instructions

1. Reach between the belt with the Shaft Cleaning Tool to scrape deposits from the inner shield.

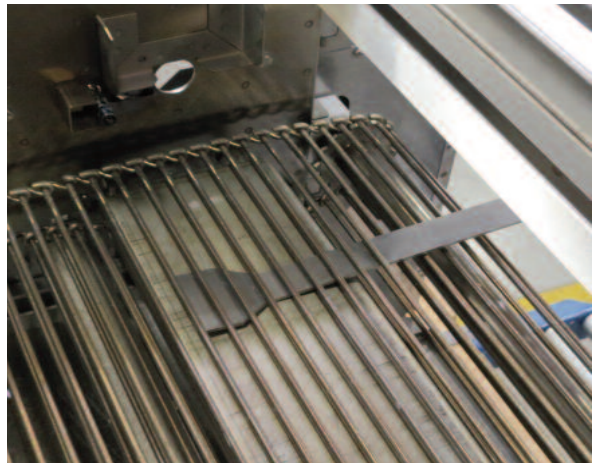

## BELT ADJUSTMENT

As Needed



### Tools



### Instructions

1. Remove return slide and stripper blade.
2. Loosen slotted crossbar bracket.
3. Pry on shaft to adjust belt.
4. Tighten bolts.

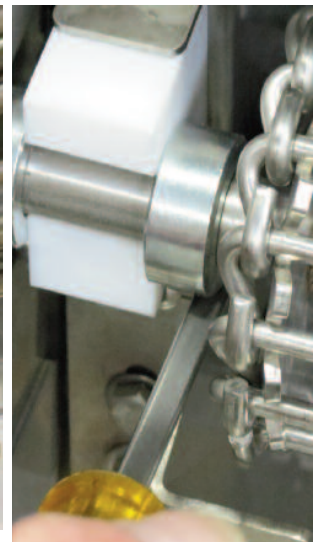

## Upper Burner/Air Boxes

Clean: Daily



### Tools



Heat Resistant

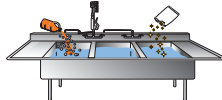

3-Compartment Sink



Scrub



### Instructions

1. Lift air upper burner and air box from the top of the broiler. It is not necessary to detach them.
2. Use a stiff brush to clean any clogged burner holes.

 Be sure that both air box assemblies are installed and sit flush on their brackets.

### Top

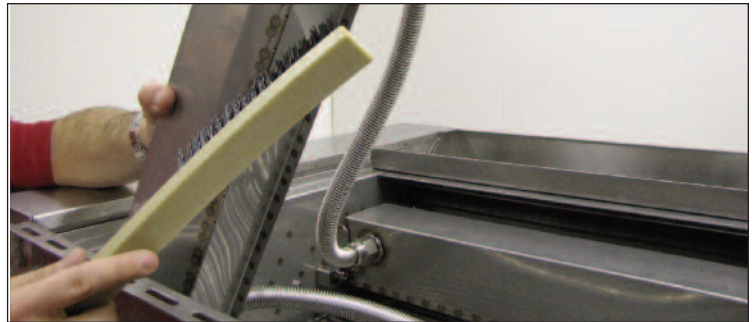
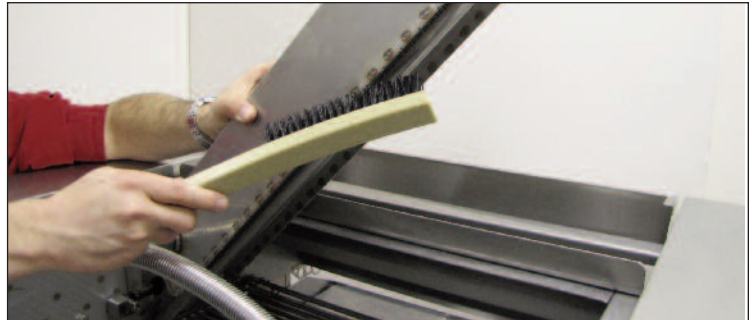

## Main Burner Orifices

Clean: Monthly



### Tools



Small Orifice  
Brush



### Instructions

1. Use a small brush to clean the main burner orifices

### Side

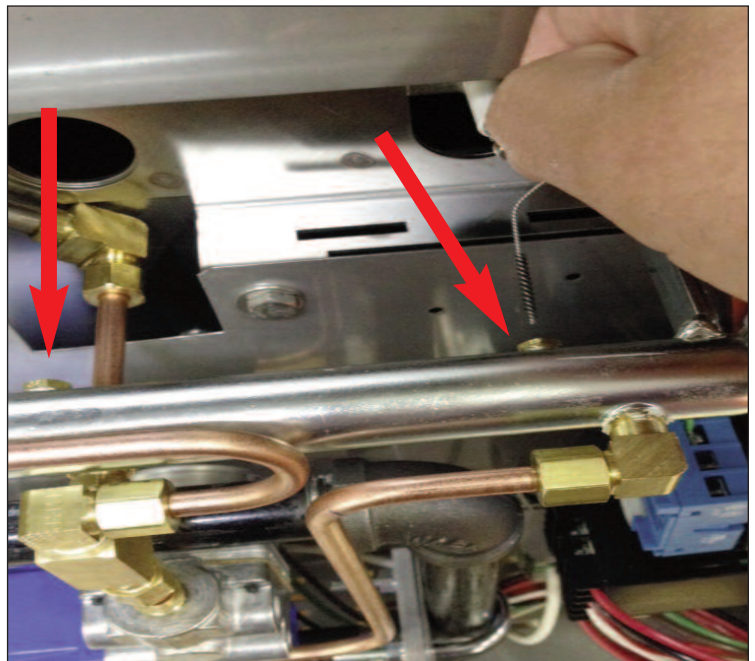

## Pilot Orifices

Clean: Monthly



### Tools



Flat Head  
Screwdriver



### Instructions

1. Disassemble and clean the pilots and orifices.

### Interior

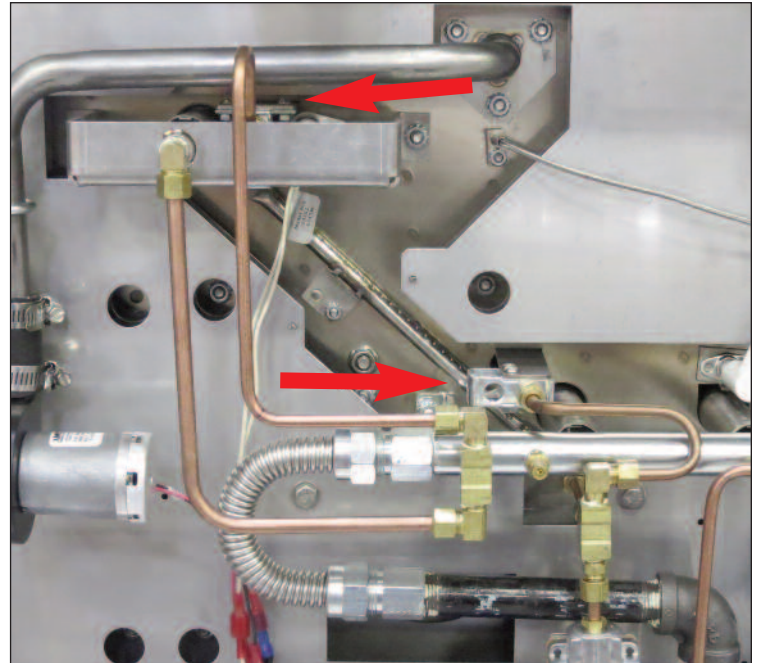

## Flame Sensor

Clean: Monthly



### Tools



Scrub



### Instructions

1. Remove the left side control box cover.
2. Remove the ceramic boot from the back of the flame sensor.
3. Loosen the wing nut holding the flame sensor in place.
4. Remove the flame sensor and clean the metal tip with a DRY, clean scrub pad.

### Side



## E. TROUBLESHOOTING

**Always verify that the broiler is properly assembled, the hood is on, gas valve open and broiler is plugged in.**

No power to broiler when the switch is turned on.	Check: Broiler is plugged in. Ventilation hood is on. Circuit Breaker on wall panel is on.
Broiler has power, but the burners do not light.	Check: Ventilation hood is on. Gas line is properly plugged in. Manual gas valve (if equipped) is on. Burners are installed properly. Burners are clean and dry. Flame sensor wire connection. Follow manual lighting instructions.
Red light blinking on left control box.	Check the items above for burners not lighting. Turn power off and on again to reset ignition. Follow manual lighting instructions.
Hot surface ignitor does not heat.	Check for loose wires connecting the hot surface ignitor. Follow manual lighting instructions.
Power is on, broiler is lit, but the conveyor belts are not turning.	Check for a jam in the conveyor belt. Check the stripper blade and the flame arrestors to make sure they are installed properly.
Feeder belt not moving.	Make sure the feeder is assembled properly. Check for jam. Make sure the drive pin is engaged.
Feeder jams.	Make sure the burgers are not frozen together.
Burgers sticking to slide or stripper blade.	Clean the slide and stripper blade very thoroughly. Check cookout temperature (undercooking).
<b>COOKING PROBLEMS</b> Burgers under or over cooked.	Adjust conveyor belt speed. Clean burners and orifices.
Excessive flaming in broiler.	Clean the catalyst if equipped. Check the hood for proper operation. Check product for overcooking.

# F. PARTS LOCATION DRAWINGS

## Discharge End View

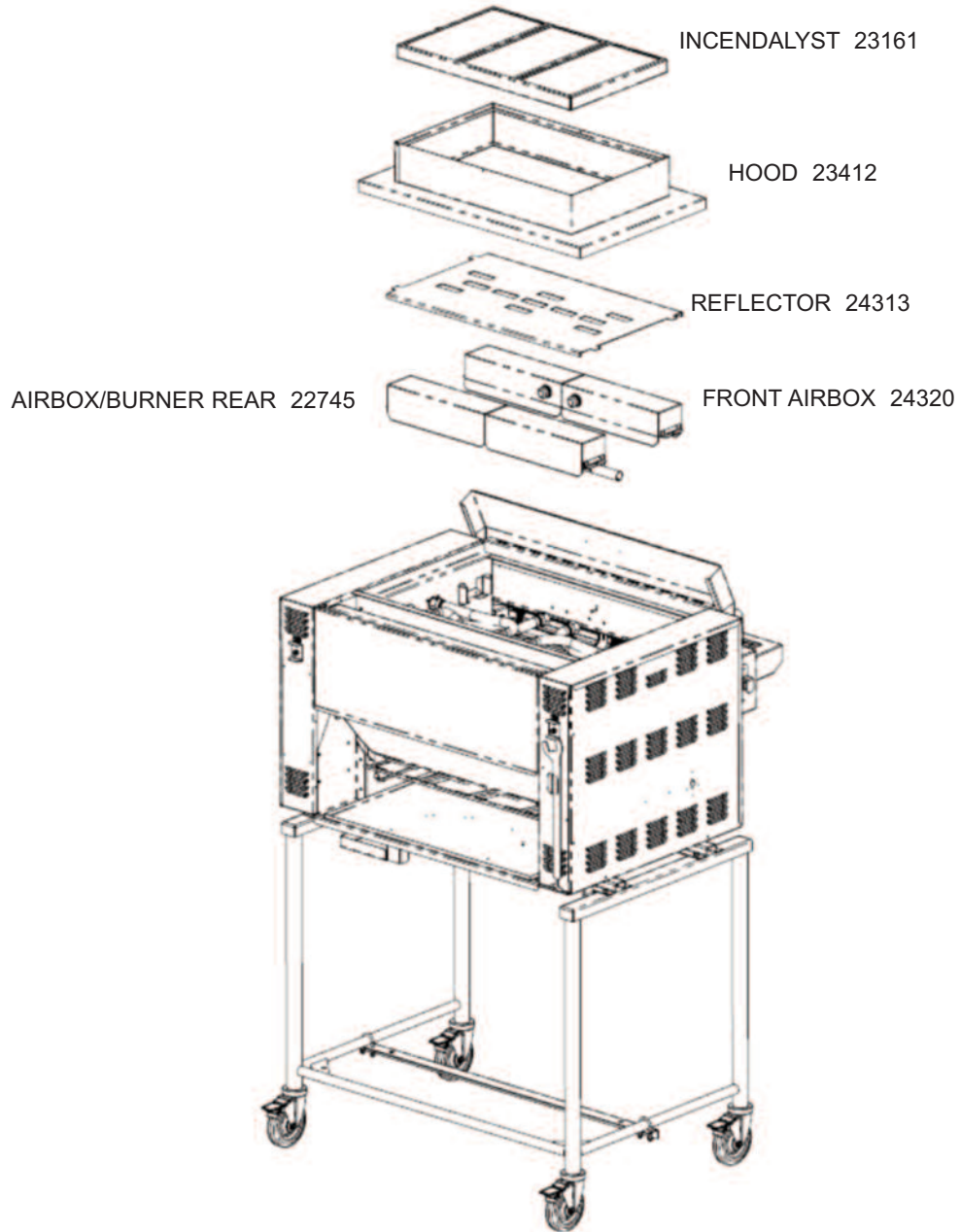

# F. PARTS LOCATION DRAWINGS

## Feed End View

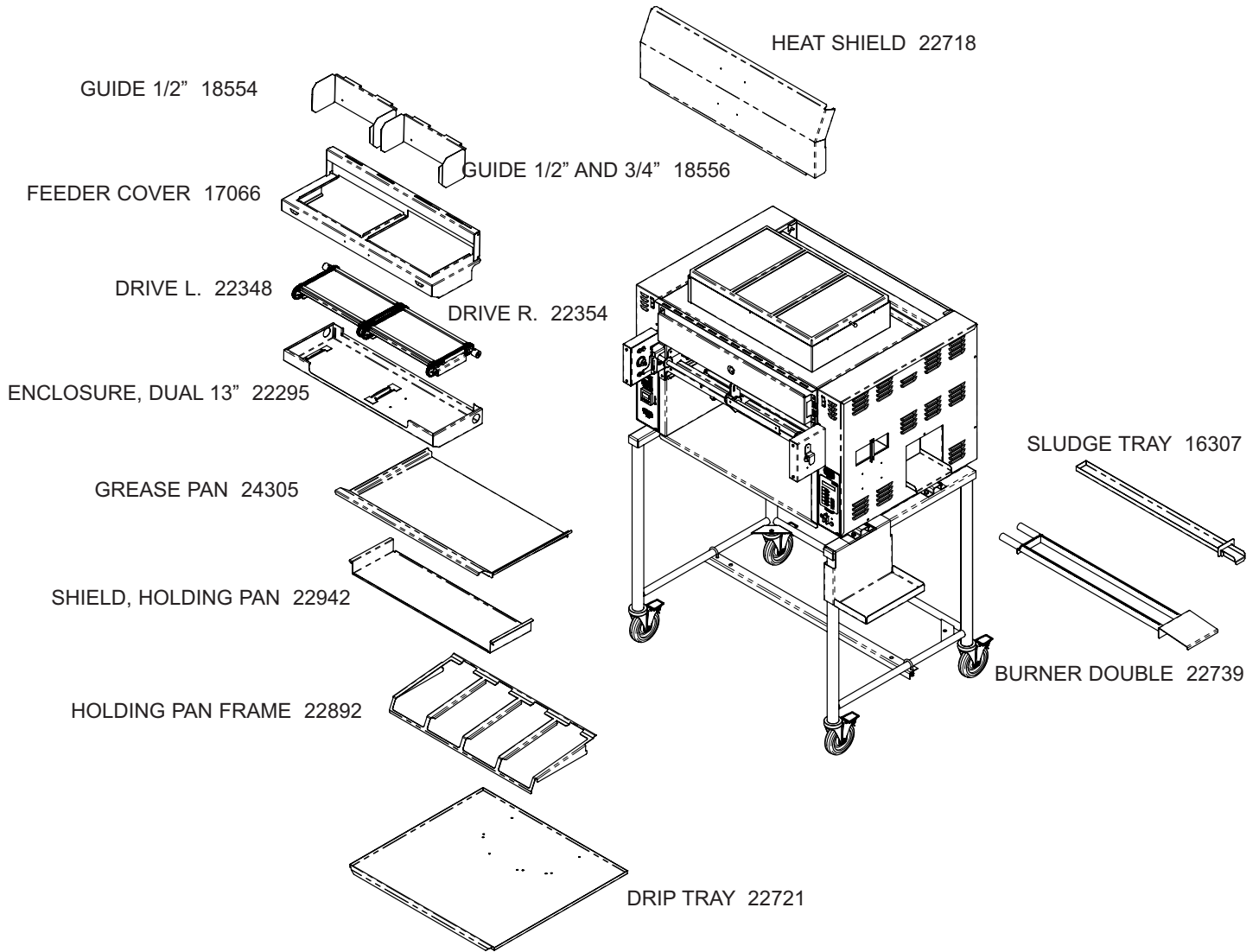



# F. PARTS LOCATION DRAWINGS

## Feeder Assembly

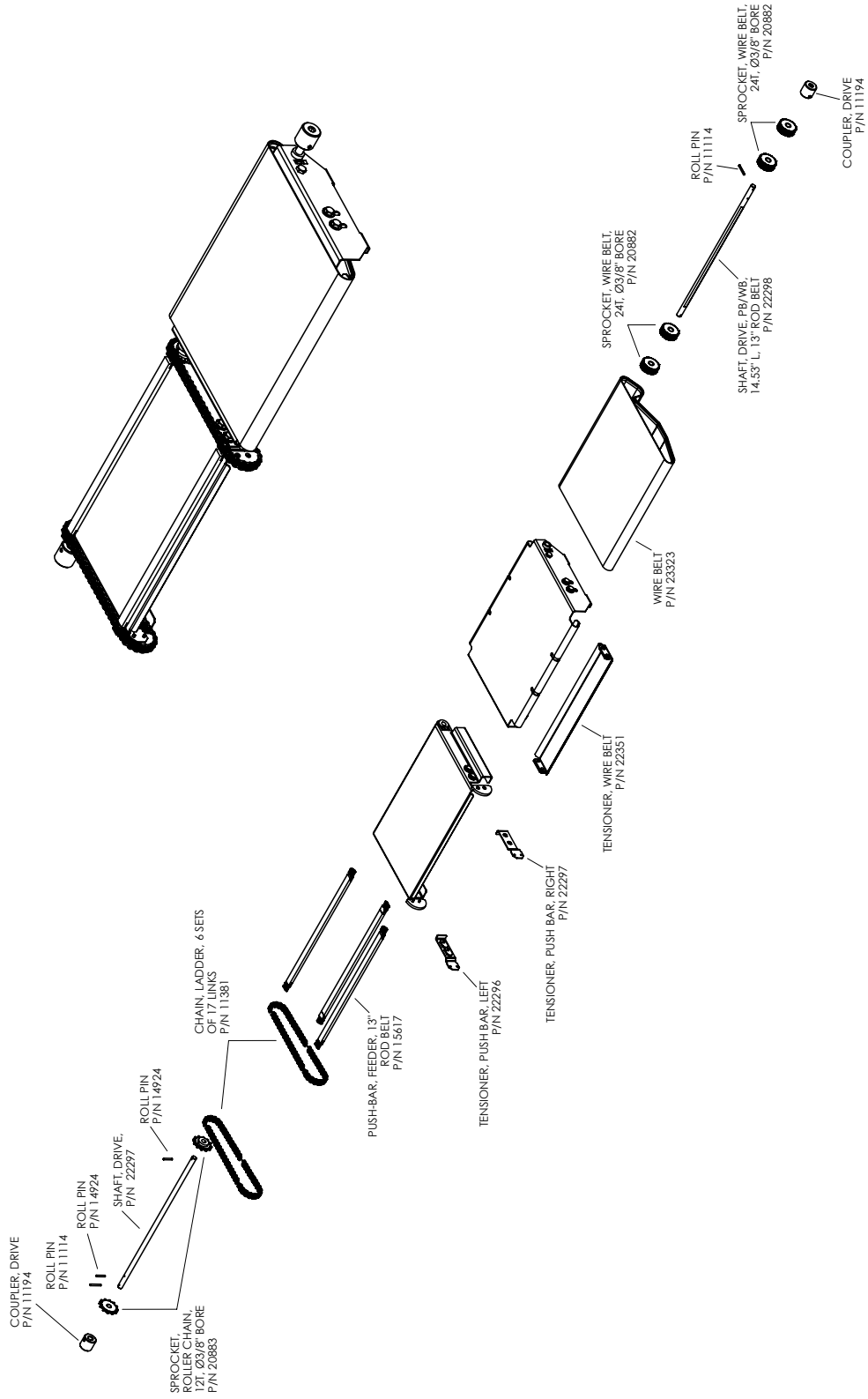

# F. PARTS LOCATION DRAWINGS

## Clutch Assembly

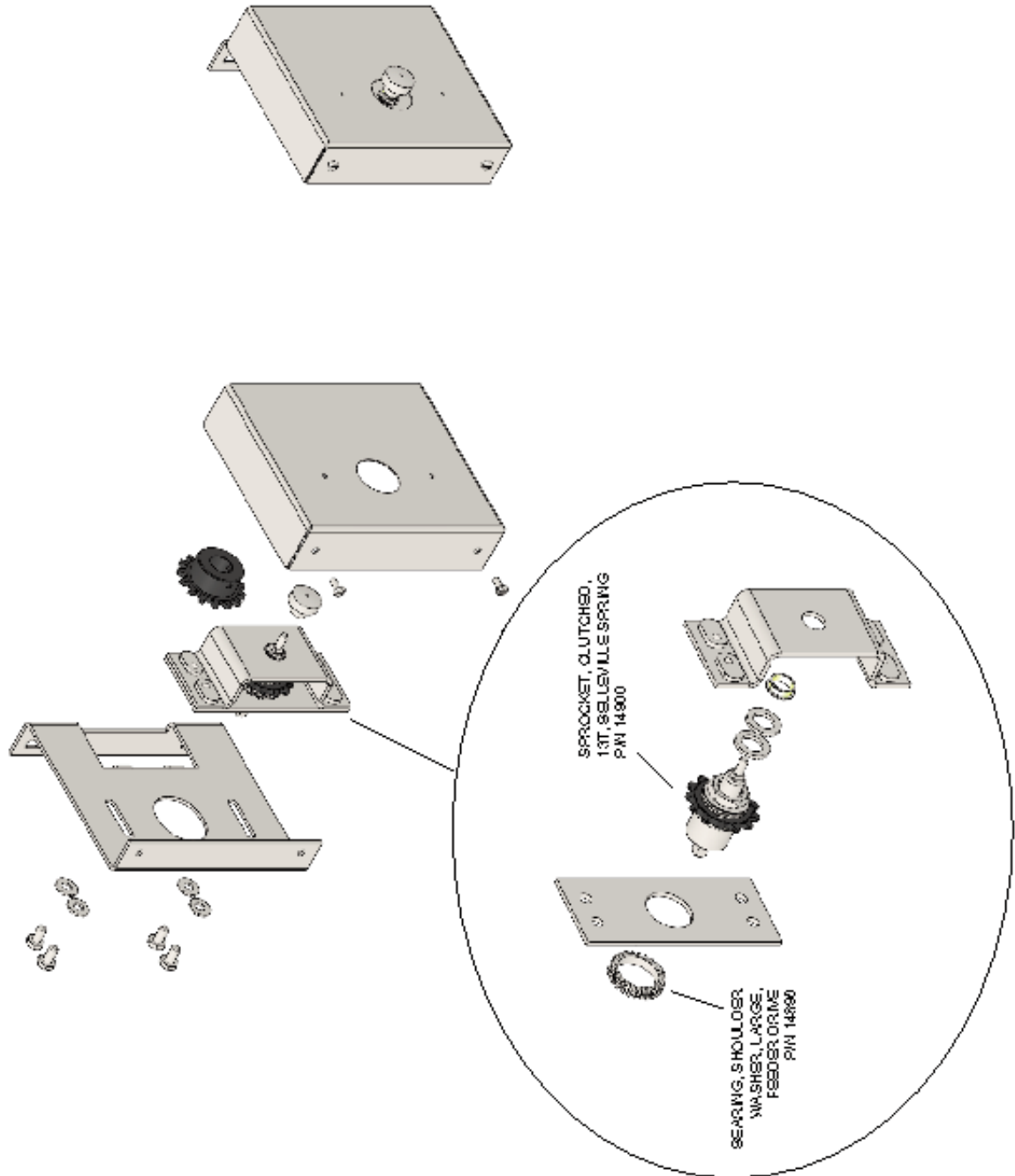

## G. PARTS REPLACEMENT LIST

<u>PART NO</u>	<u>DESCRIPTION</u>
<b>GAS BURNER &amp; AIR</b>	
22745	AIR BOX W/ BURNER (REAR)
24320	AIR BOX (FRONT)
23430	UPPER HEAT REFLECTOR
22739	LOWER BURNER, DOUBLR FULL
22626	AIR TUBE MANIFOLD LH
23333	AIR TUBE MANIFOLD RH
20909	FLEXIBLE CONNECTOR (3/4 X 16)
19277	FLEXIBLE CONNECTOR (3/4 X 8)
18447	BLOWER
<b>IGNITION SYSTEM</b>	
2047	LOWER PILOT ORIFICE NAT (5232)
2182	UPPER PILOT ORIFICE NAT (3225)
18152	UPPER BURNER ORIFICE - FLAT TIP NAT #52
2070	LOWER BURNER ORIFICE NAT# 40
22930	ZIP TUBE ORIFICE NAT #70
17276	UPPER & LOWER PILOT ORIFICE LP (4214)
18159	UPPER BURNER ORIFICE - FLAT TIP LP #59
2066	LOWER BURNER ORIFICE NAT# 53
23481	ZIP TUBE ORIFICE LP #78
2179	PILOT BURNER - LOWER
2180	PILOT BURNER - UPPER
18096	VALVE, PRESSURE TAP
10291	IGNITER (GLOW PLUG)
17185	FLAME SENSOR
18052	IGNITION WIRE / BOOT
2049-A	REGULATOR, RV48, 1/2"
21316	VALVE, Ø½, MODULATING, 24V
19054	SOLENOID VALVE, 1/2 NPT, 24VAC
16921	IGNITION MODULE
17201	IGNITION FAILURE LIGHT
12741	SOLENOID VALVE - 24V - PILOT SHUTOFF
20786	GEAR MOTOR,DC,BRUSHLESS,REVERSE SHAFT
18168	MOTOR CONTROL CABLE

## G. PARTS REPLACEMENT LIST

<b>BELT DRIVE</b>	
6027	# 35 DRIVE CHAIN
6048	MASTER LINK
6035	13" ROD BELT (5FT EACH SIDE)
6046	TEFLON BEARING (DISCHARGE OUTER DRIVE SHAFT)
6047	TEFLON BEARING (DISCHARGE INNER DRIVE SHAFT)
6049	TEFLON BEARING (FEED END)
20774	BEARING BLOCK, ALUM/BRZ
17899	MOTOR SPROCKET - 10T (10MM BORE USED WITH P/N 17932)
13699	DRIVE SPROCKET -32T
11081	IDLER SPROCKET - 19T
6037	IDLER SHAFT SPROCKET, 35B15, 5/8" BORE
18997	OUTER DRIVE SHAFT
35900	FLANGED BUSHING - OUTER DRIVE SHAFT
19862	INNER DRIVE SHAFT
15565	IDLER SHAFT - 13"
6300	CROSS ROD - TENSION SHAFT
6028	SET COLLAR - 5/8"
19912	BRACKET - U - TENSION SHAFT
<b>ELECTRICAL</b>	
22965	WARMER ELEMENT - 120V - 1100W DOMESTIC
16599	WARMER ELEMENT - 220V - 1100W EXPORT
4402	GREEN LIGHT - 28V
22929	MAIN TRANSFORMER
16034	TRANSFORMER - TEMP CONTROL
19076	TEMPERATURE CONTROL
13727-B	SPEED CONTROL
4136	SPEED CONTROL BASE - 8PIN
15161-B	MULTI-PRODUCT CONTROL
15480	MAIN ON/OFF SWITCH - ROCKER - 50A
12725	BRIDGE RECTIFIER
18092	8 PIN RELAY BASE, DIN MOUNT
18093	8 PIN RELAY, 24COIL
13579	MOTOR REVERSE SWITCH
18861	TEMPERATURE PROBE - 1.88"
4405-01	END STOP
18871	TERMINAL BLOCK - GRAY - MAIN POWER
18873	TERMINAL BLOCK - GROUND - MAIN POWER
18872	END COVER - MAIN POWER
4405-31	FUSE HOLDER - TERMINAL BLOCK
4405-30	END SECTION - GRAY - FUSE HOLDER
4621-02	FUSE 2A
4621-0025	FUSE .25A
18686	TERMINAL BLOCK-GRAY
18688	TERMINAL BLOCK - GROUND
18687	END COVER - TEMINAL BLOCK

## G. PARTS REPLACEMENT LIST

<b><u>SHEET METAL</u></b>	
22616	ELECTRICAL BOX COVER - RH
22615	ELECTRICAL BOX COVER - LH
22718	FEED END HEAT SHIELD
22724	HEAT SHIELD - REAR
23431	REAR SLIDE - 4 LANE
24305	GREASE PAN
22940	STRIPPER BLADE 13" & 13"
16402	MOUNTING BRACKET - STRIPPER BLADE - LH
16403	MOUNTING BRACKET - STRIPPER BLADE - RH
16307	SLUDGE TRAY
22898	HOTEL PAN (1/9" X 4")
22892	FRAME SUPPORT - HOLDING PAN - 2 LANE
22721	GREASE DRIP TRAY - BOTTOM
23412	HOOD / CHIMNEY
22942	WARMER PAN SHIELD
22936	TOOL, SHAFT CLEANING, 12" LONG
<b><u>FEEDER</u></b>	
17066	FEEDER COVER
22295	ENCLOSURE
22348	DRIVE UNIT PUSH BAR - LH
22354	DRIVE UNIT PUSH BAR - RH
15617	FEEDER BAR - 13"
11381	FEEDER CHAIN
11478	FLANGE BUSHING - PUSHBAR FEEDER
22296	TENSIONER BRACKET - PUSHBAR FEEDER LH
22297	TENSIONER BRACKET - PUSHBAR FEEDER RH
18554	PATTY DIVIDER MAIN SIDE
18556	PATTY DIVIDER FLEX SIDE
20504	CLUTCH COVER
17494	CLUTCH RESTRAINT BRACKET
15882	COMPLETE CLUTCH ASSEMBLY
14900	COMBO CLUTCH - ONLY -
14896	BEARING / SHOULDER WASHER-WHITE- (CLUTCH ASSEMBLY)
10275	THRUST WASHER
10627	BEARING CLIP
11608	BLACK KNOB - CLUTCH ASSEMBLY
20975	FEEDER MOUNTING BRACKET - LH
20976	FEEDER MOUNTING BRACKET - RH
20503	BRACKET, CLUTCH MOUNTING
<b><u>MISCELLANEOUS</u></b>	
20860	8 X 15 X 1.5 CATALYST
25332	CLEANING TOOL, COMBO
25333	TOOL, SHAFT CLEANING
23307	CLEANING BRUSH
9133	ROD BELT PLIERS
9134	#35 CHAIN BREAKER TOOL
12744	GAS LINE 3/4

# H. WIRING DIAGRAMS

## 115V Wiring

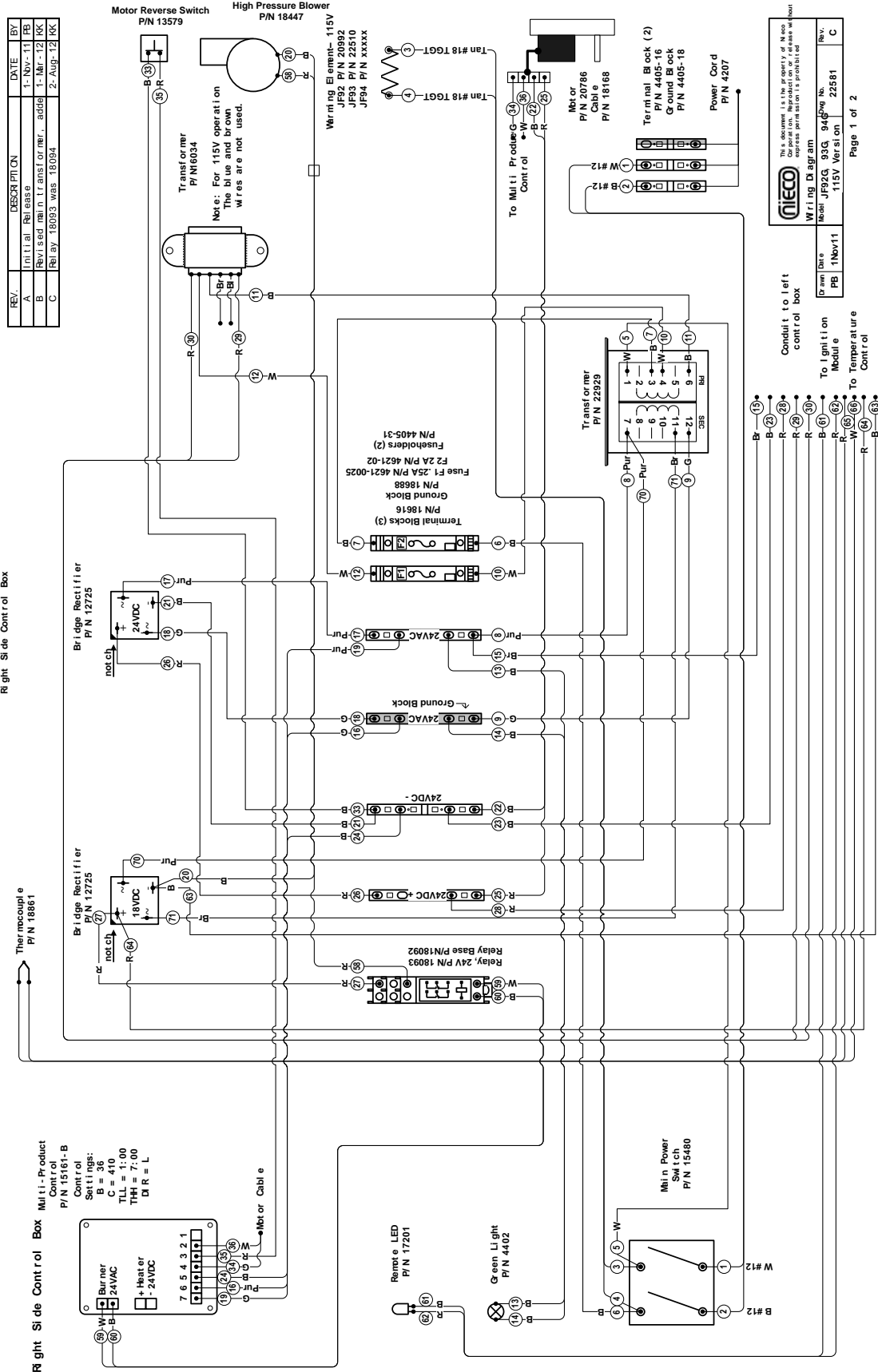

# H. WIRING DIAGRAMS

## 115V Wiring

This document is the property of Nieco Corporation. Reproduction or use without express permission is prohibited.	Rev. C
Drawn by: PB 11Nov11	Eng. No: 22581
Model: JF94G, 93G, 94G	115V Version
Page 2 of 2	

Left Side Control Box

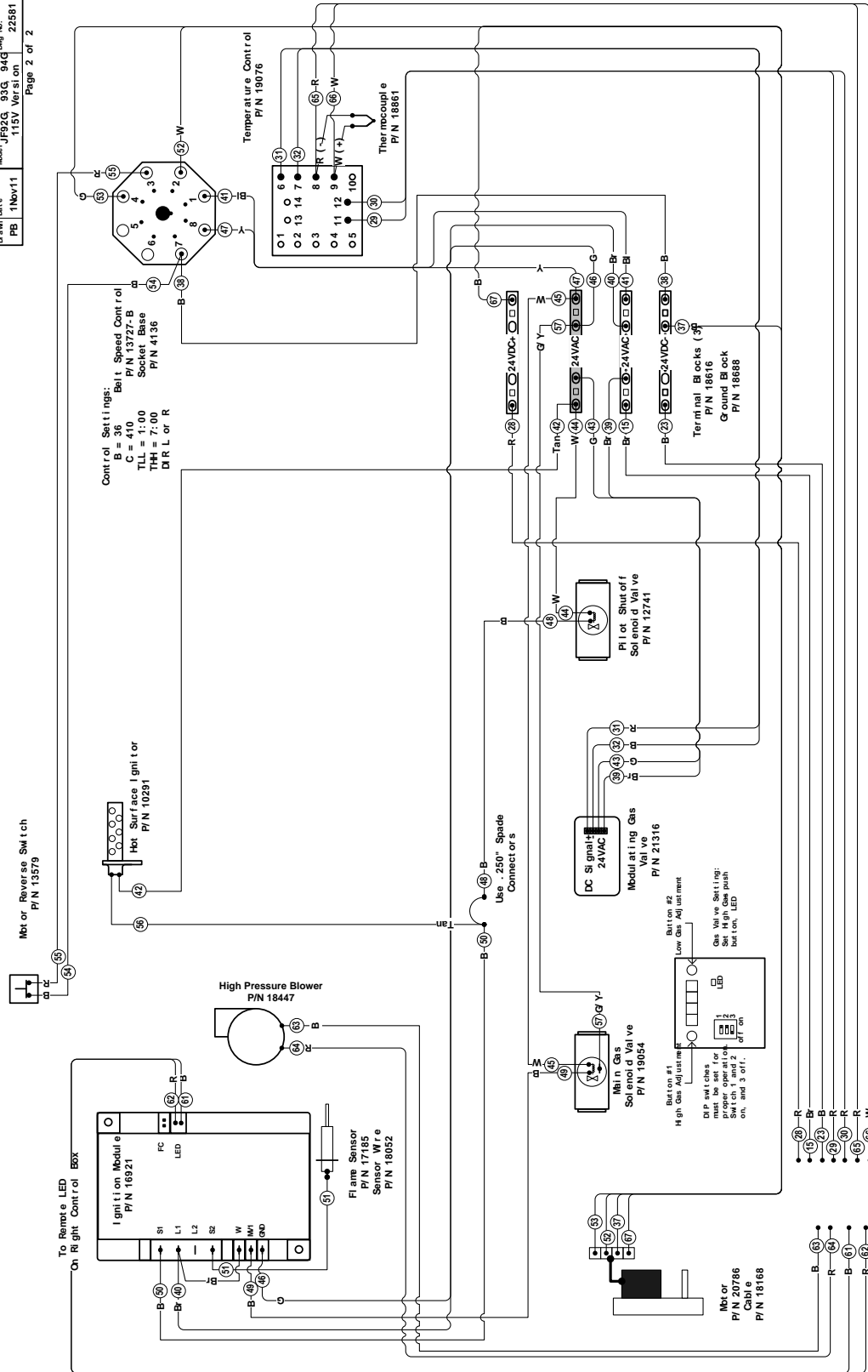

# H. WIRING DIAGRAMS

## 230V Wiring

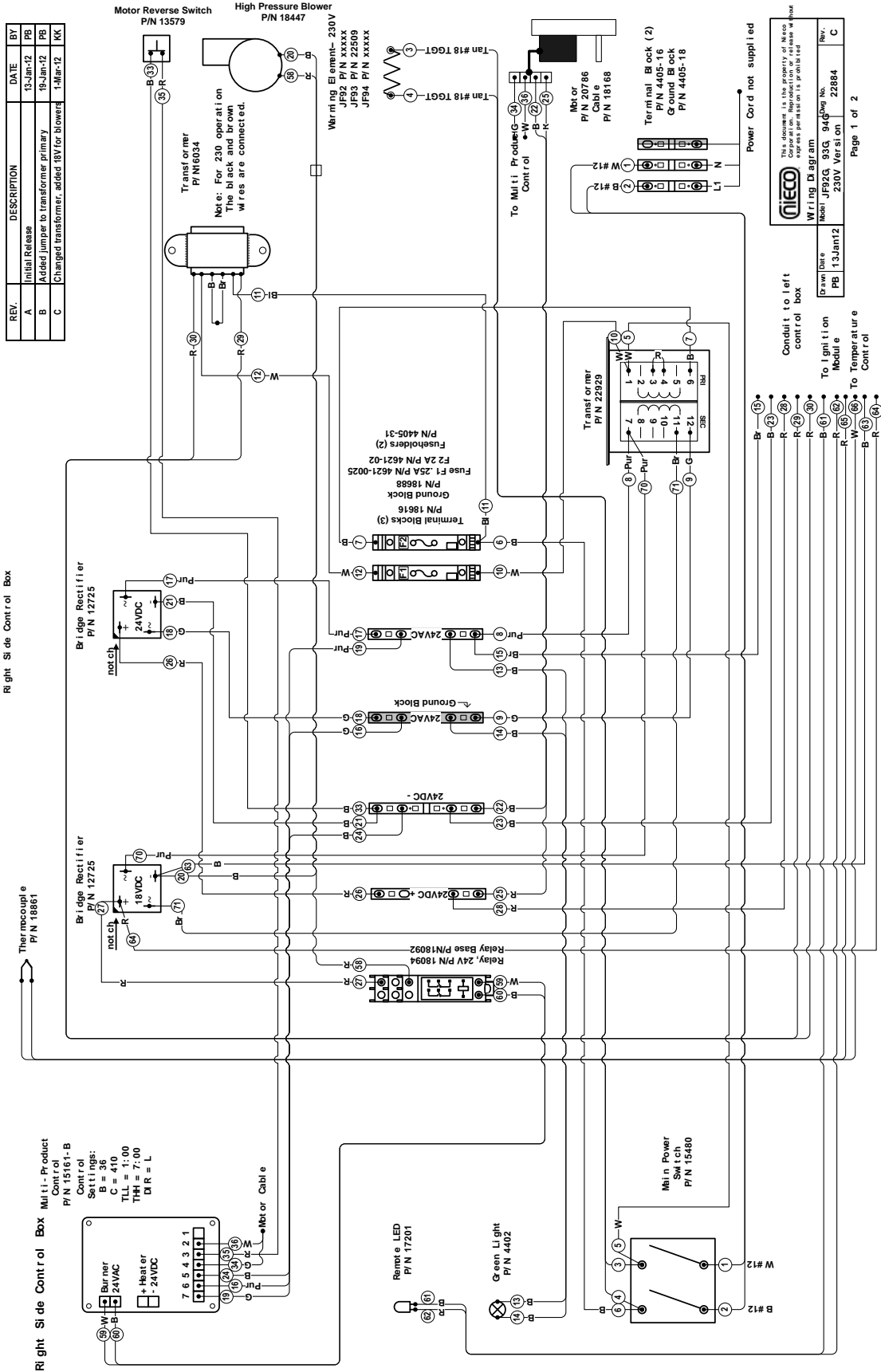

REV.	DESCRIPTION	DATE	BY
A	Initial Release	13-Jan-92	PB
B	Added jumper to transformer primary	19-Jan-92	PB
C	Changed transformer, added 18V for blower	14-Mar-92	RK

**NIECO**  
 This document is the property of Nieco Corporation. Reproduction or release without express permission is prohibited.

Wiring Diagram  
 Model JF94G, 93G, 94G  
 230V Version  
 P/N 22884

Drawn Date	Rev.
PB 13Jan92	C





# H. WIRING DIAGRAMS

## 230V Wiring

This document is the property of Nico Corporation. Reproduction or use without express permission is prohibited.	Rev. C
Drawing Date: PB 13 Jan 14	Drawing No.: 22884
Model: JF94G	Voltage: 230V
Page 2 of 2	

Left Side Control Box

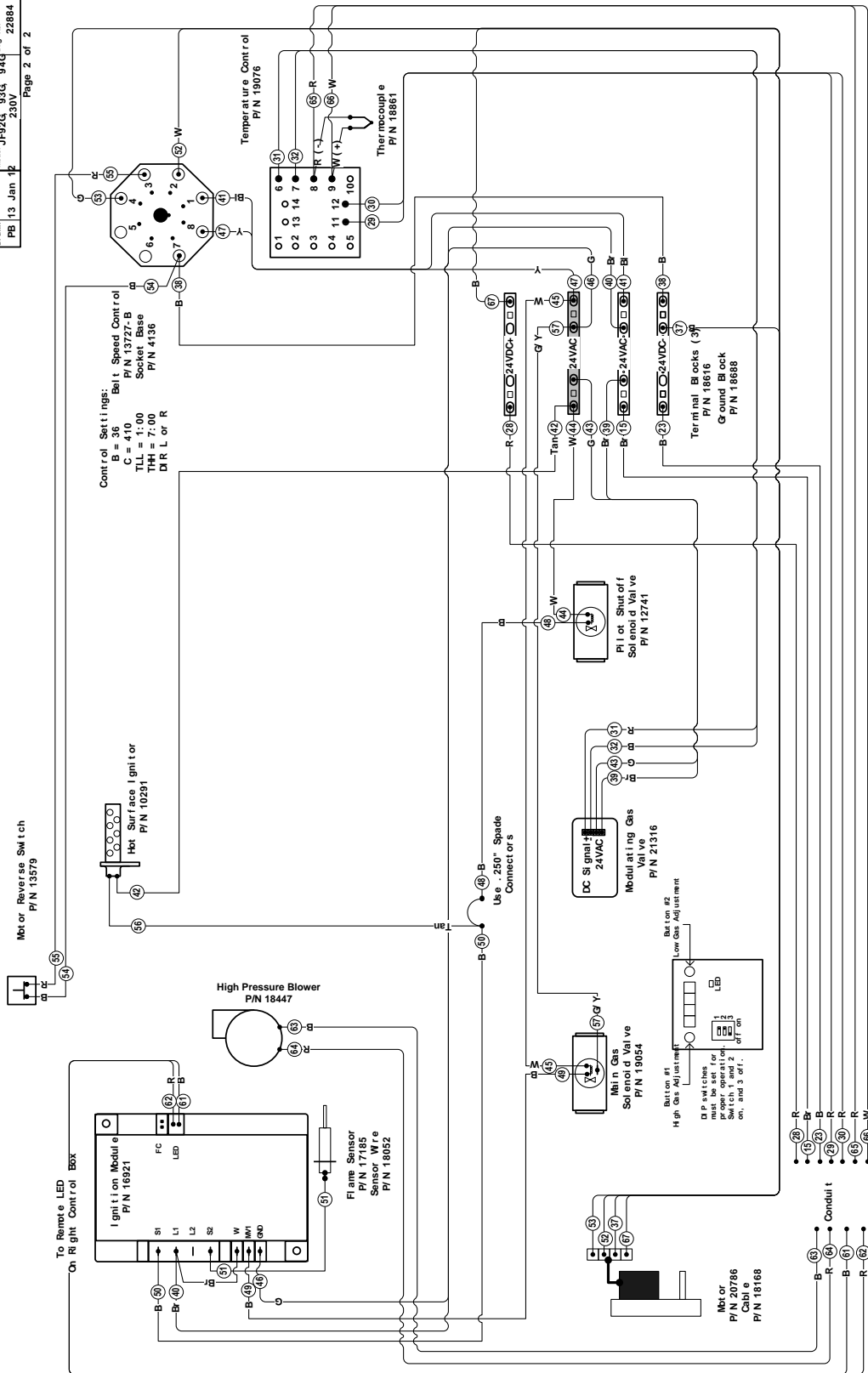

This page intentionally left blank.

# I. SPECIFICATIONS

## AUTOMATIC BROILER

Model JF94

DIMENSIONS	INCH	MM
Length	39.32	999
Height	65.75	1670
Width	42.17	1071

## ENERGY

Gas connection 3/4" N.P.T.

Electrical connection (specify exact voltage)

115V 11A or 220V 6A

Natural/LP Gas Operating Usage

Average usage::

BTU/hr 75,000

WEIGHT	LBS	KG
Broiler	565	256

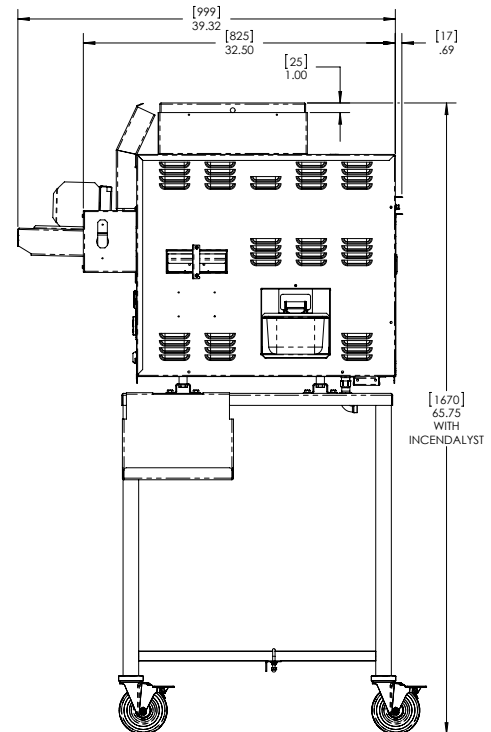
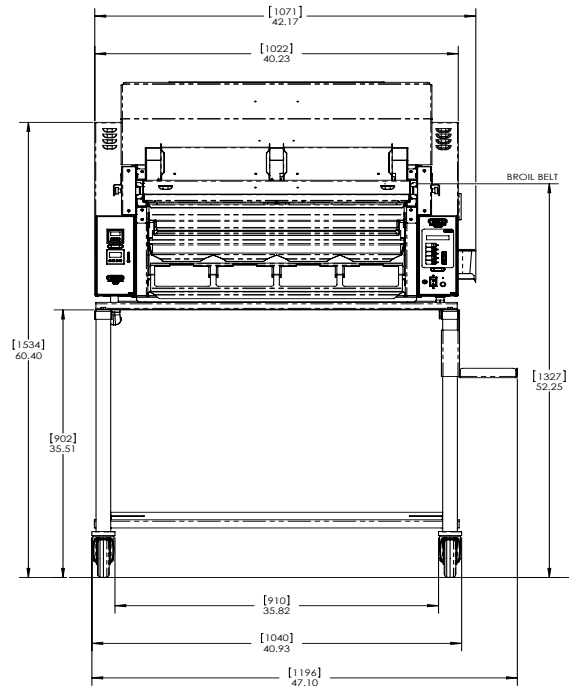

**⚠ CAUTION ⚠**

All electrical connections must be in accordance with local electrical codes and any other applicable codes.

**⚠ CAUTION ⚠**

Do not operate the broiler at gas pressures other than those stated here. Doing so will affect the operation of your broiler.

Revision History:

Date	Notes	REV
1-3-2012	Released	A
3-28-2013	Updated drawings, Calibration, added cleaning inner shield, belt adjustment	B
4-16-2014	Updated drawings, specifications, parts listings, photos, procedures.	C



**Nieco Corporation**

7950 Cameron Drive

Windsor, CA 95492

(707) 284-7100 Office • (707) 284-7430 Fax

[www.nieco.com](http://www.nieco.com) • e-mail: [service@nieco.com](mailto:service@nieco.com)

Printed in the USA © 2012 Nieco Corporation

All Rights Reserved P/N 99002